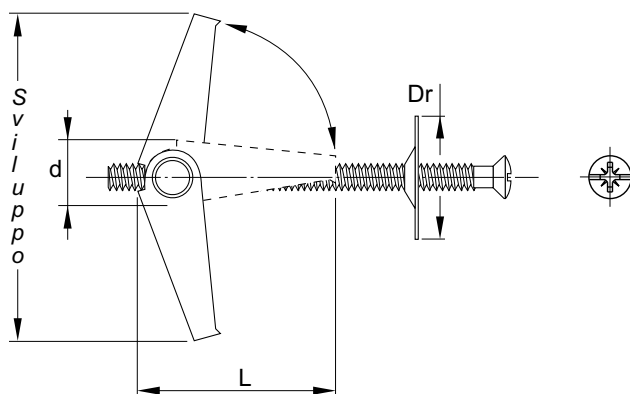
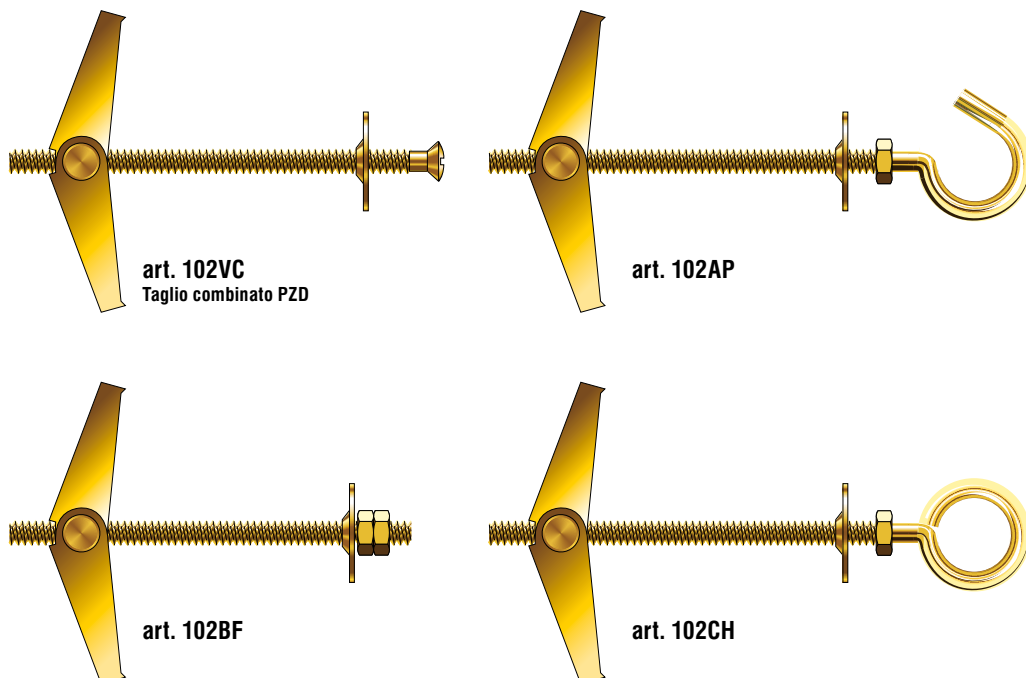

art. 102
TASSELLO A FARFALLA

Impiego - Caratteristiche

Impiego

Soffitti a muratura vuota, profilati.

Caratteristiche

Corpo: Acciaio tropicalizzato

Vite: Acciaio zincata M5 ✓

Cilindro: Ottone M5

art. 102

Codice	d Diametro foro	dv Diametro vite	Sviluppo	L	Dr Diametro rondella	Confezione	Imballo	Euro x 1000 pz
102VC	14	M5 x 80	46	30	25	50	400	
102BF	14	M5 x 100	46	30	25	50	400	
102AP	14	M5 Aperto	46	30	25	50	400	
102CH	14	M5 Chiuso	46	30	25	50	400	